

K 600 Edge Banding Machines – Pure Precision





So You Think There Is Always Room for Improvement? Welcome to HOMAG

In today's world, good is simply no longer good enough. Only by delivering absolute premium quality can you be sure to stay ahead of your competitors. A furniture panel tells its own story about how and on which machine it was produced. The edge progression and joint quality must be just right every time – and investing in plants and machines from HOMAG means you know they will be. The use of high-performance HOMAG machines guarantees excellent efficiency and thanks to high availability and consistent first-class quality, your customers will always receive impressive products.

We are **YOUR SOLUTION**

Content

- 04 K 600 – a Machine to Place You Firmly in the Champions League
- 06 The HOMAG K 600 series
- 07 Flexible Longitudinal and Transverse Processing with Workpiece Infeed Systems – or Simply Call It “Precision Work”
- 08 Efficiency Through Series Production
- 10 Flexible Production Down to Batch Size 1
- 12 Dynamic Edge Circulation Solutions
- 14 Greater Economy Due to a Long Service Life and Optimum Availability
- 16 Our Range of Modular Units – Always Up To Date
- 34 Productivity – Only as Good as the Control System
- 36 HOMAG Life Cycle Services
- 38 Technical Data K 600



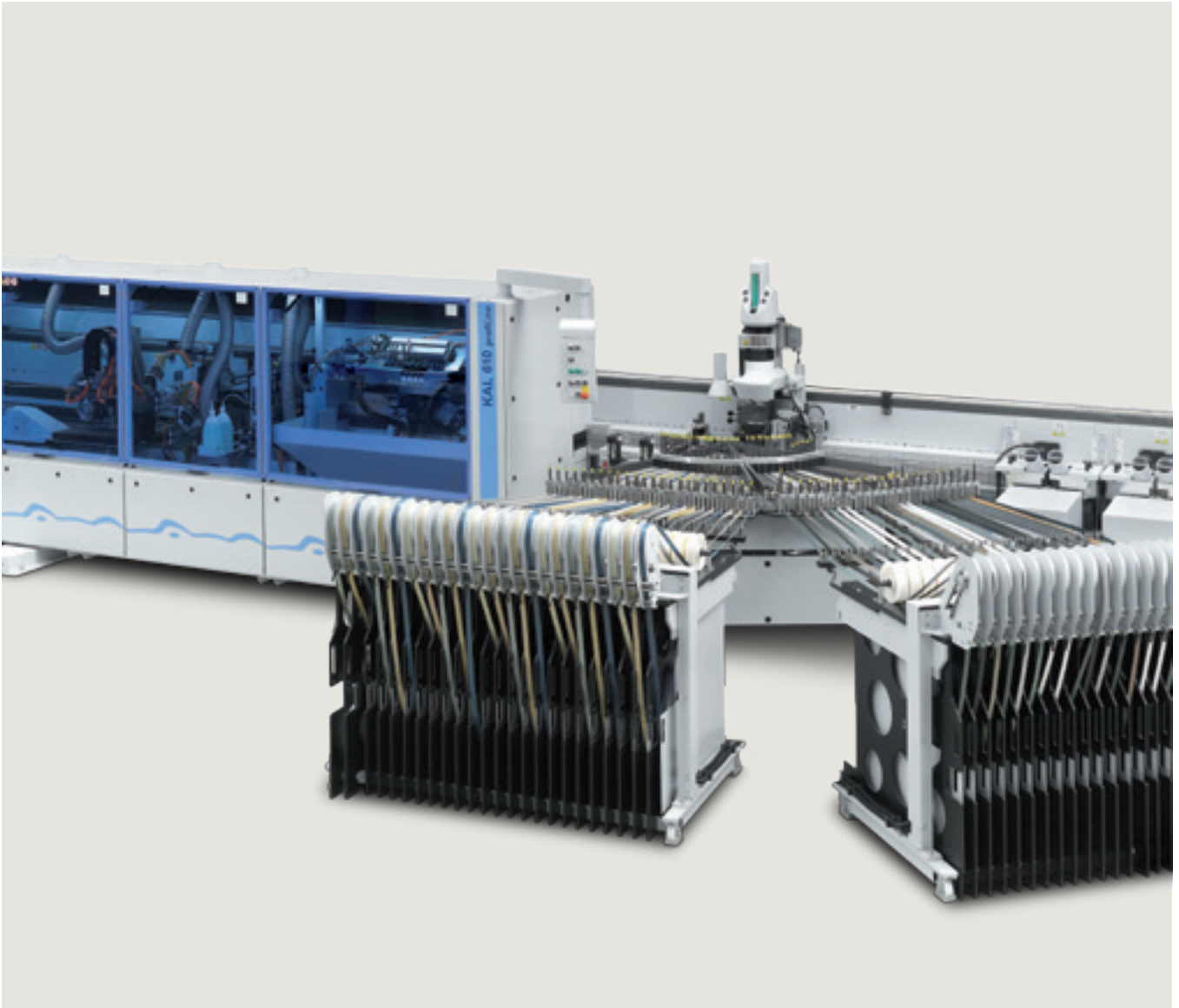

K 600 – a Machine to Place You Firmly in the Champions League

The machine equipment, the processing unit configuration – every aspect of the K 600 offers the ultimate in terms of freedom, performance and flexibility. After all, it was designed with the highest production category in mind. With HOMAG edge banding machines from the K 600 series you can profile, rebate and groove panel-shaped workpieces such as chipboard, MDF, coreboard panels, solid wood and plastic, for example. And it goes without saying that workpieces

can be edged using hot-melt, PU adhesive or zero joint technology with any kind of popular edging material: natural or plastic, coils or fixed length material. Choose between a KAL 600, which processes pre-sized workpieces in unfinished fixed dimensions or the KFL 600, which is capable of component sizing, edge application or finish processing.



**Single-sided machines type 610:
width-independent and flexible**

The gold standard for order-related production. An edge is banded onto the relevant workpiece side with each machine pass. Because these machines work independently of width, they offer extreme flexibility of application. Using workpiece infeed systems, they are capable of achieving high capacity levels both with pre-sized and unsized workpieces.

**Double-sided machines type 620:
series furniture production**

The classical application for double-sided machines and machine lines: large-scale series production. These machines are distinguished by extremely high output and minimal resetting processes. At the same time, they offer almost unlimited scope for equipment.

**Batch size 1 with type 610:
flexibility plus performance**

Ideal for order-related production with maximum output. Workpiece feeding ensures a high standard of precision even with extreme part dimensions. This allows the 610 machines to combine flexibility and performance with high-quality angular precision.

The HOMAG K 600 Series – as Variable as Your Production Needs

When it comes to processing your workpieces, flexibility is what counts. Which is why the machines of the HOMAG K 600 series are adjusted precisely to the varying widths of your workpieces. Choose from a wide selection of working widths from 1,000 to 3,500 mm in steps of 500 mm, with

facility for reducing the minimum working width to 210 mm. If you are processing wide workpieces, we recommend using an additional central support.



Longitudinal processing with the KFL 620

Safe stop: the workpieces are guided into the machine along the infeed fence, after which they can be cut precisely to size.

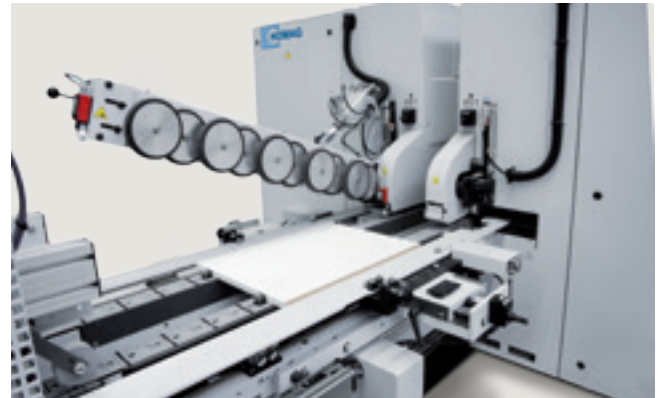

Transverse processing with the KFL 620

The steplessly adjustable cams of the transport chain form the workpiece stop. This allows even softforming parts or profiled components to be reliably transported through the machine without damage.

Flexible Longitudinal and Transverse Processing with Workpiece Infeed Systems – or Simply Call It “Precision Work”

This concept of multisided processing in consecutive passes enables high capacity levels to be reached, even for order-related production with continuously changing dimensions.

High-speed Unit resetting within a minimal gap between two workpieces represents the state of the art.

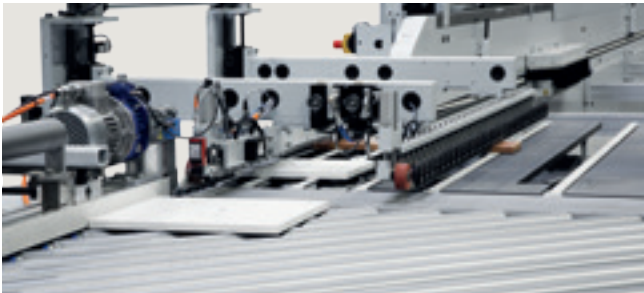

WZ10 workpiece infeed system (top)

For workpieces which have already been cut to a high level of angular and parallel accuracy with their unfinished fixed measurement, we recommend using workpiece infeed WZ10. This is configured specifically for transporting pre-sized workpieces for flexible production.

WZ14 workpiece infeed system (bottom)

A parallel precisely angled cut is not necessary with this workpiece infeed system. The workpieces are fed at a precise angle in the longitudinal and transverse direction. The machine's sizing units then cut the workpiece precisely to size. Cyclical outputs of up to 15 workpieces/min. are possible.

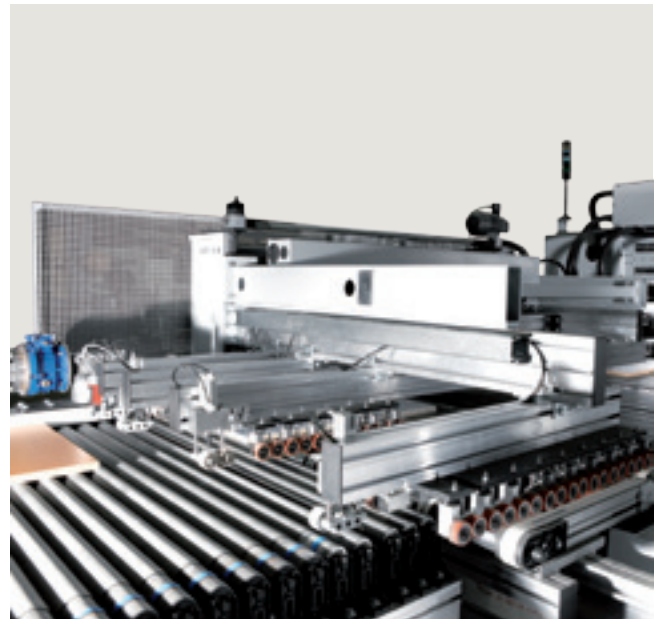

SI14 workpiece infeed system – can process anything

A parallel precisely angled cut is not necessary with this workpiece infeed system. The workpieces are fed at a precise angle in the longitudinal and transverse direction. The machine's sizing units then cut the workpiece precisely to size. Cyclical outputs of up to 30 workpieces/min are possible.

Efficiency Through Series Production

Production of today's panel furniture is inconceivable without the high-performance K 600 demonstrating the highest process reliability. The K 600 addresses your precise operating requirements reliably every time. At HOMAG, production lines are specifically designed, installed and commissioned for you by your own personal team. This

allows us to guarantee a top class solution to your specific production assignment. After all, networking individual processing machines and material flow systems is a complex task – one we tackle by putting together a specially configured HOMAG project team: your HOMAG team.

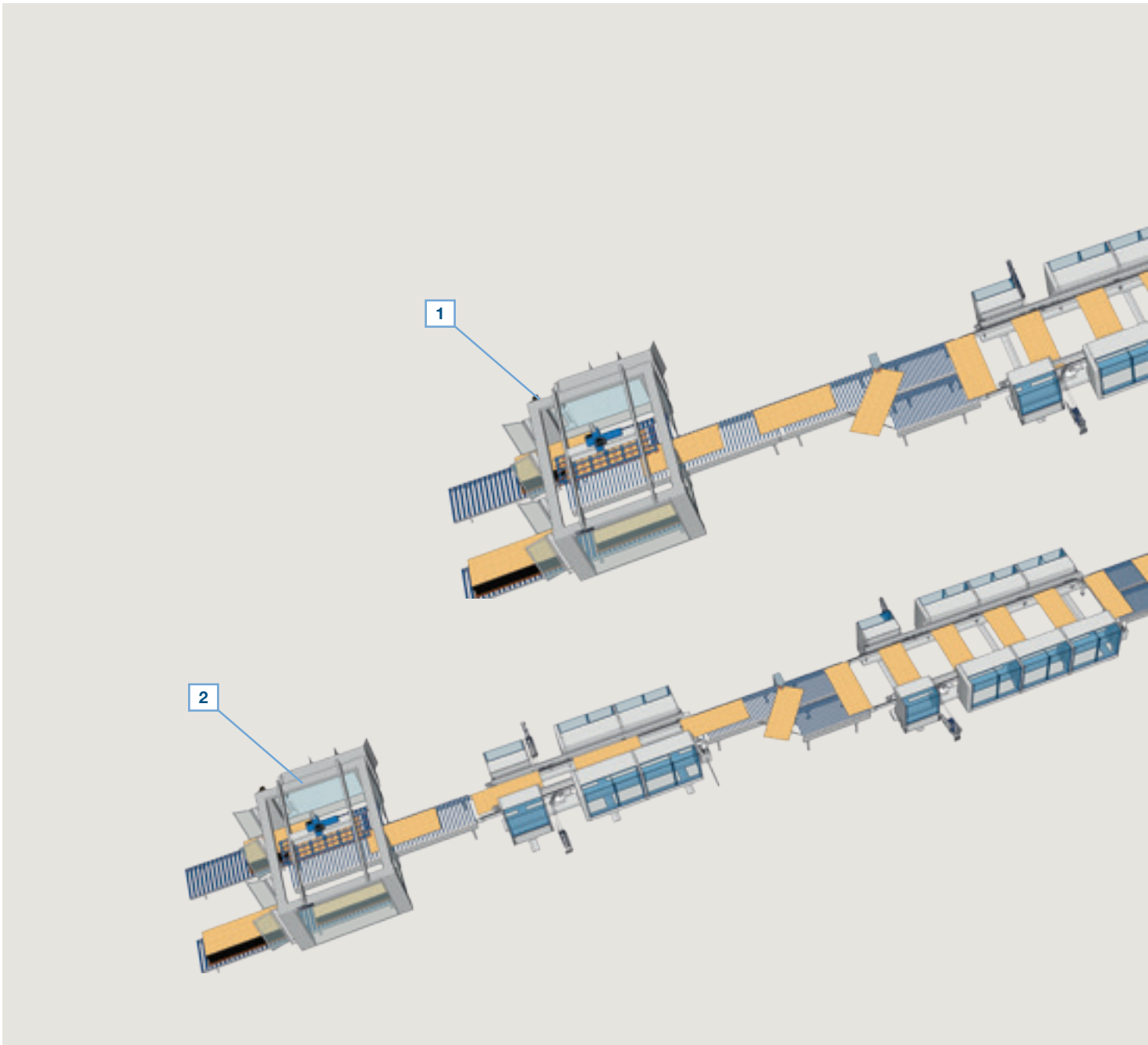

Have your HOMAG K 600 tailored to fit you – just like a suit

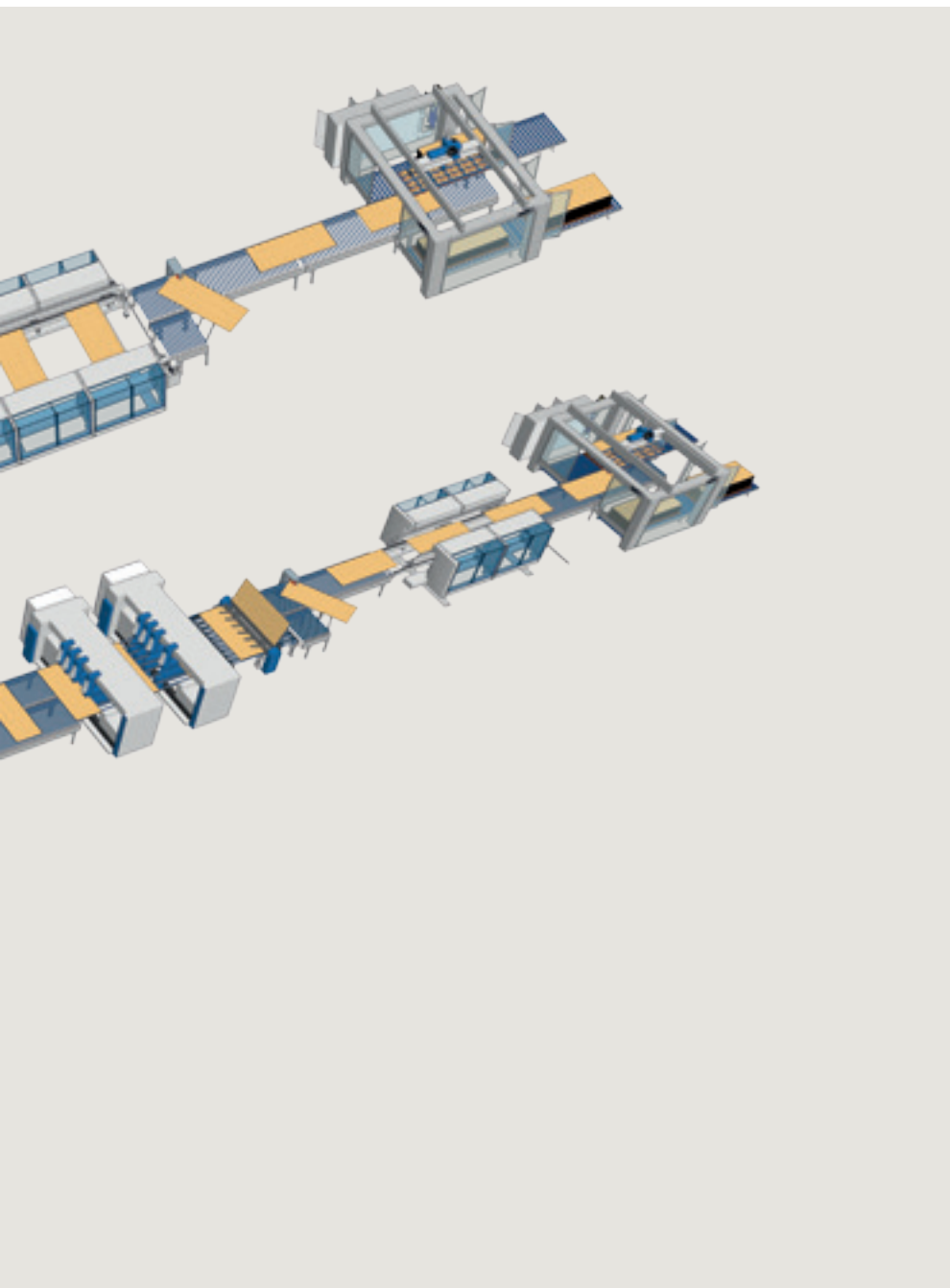
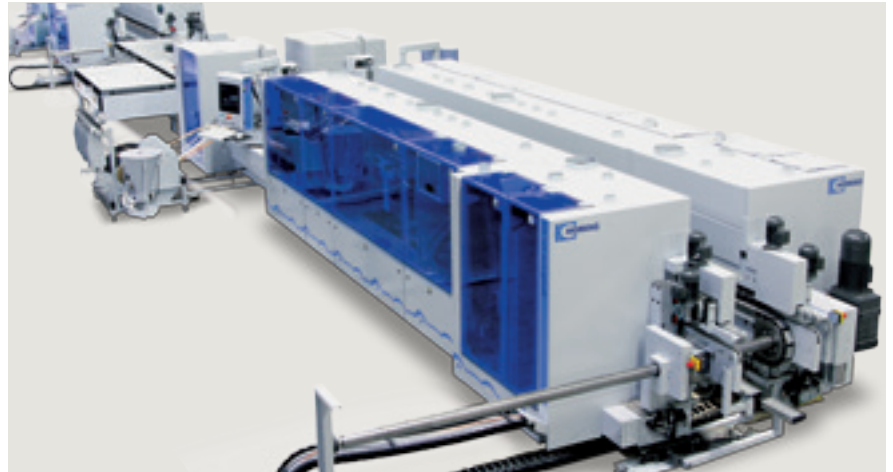

**1 SHORT MACHINE LINE –
JUST ONE OF MANY
EXAMPLES**

For medium capacity requirements. The workpieces are processed longitudinally and transversely in two work steps. To do so, stacks are transported back. Feeding and destacking systems as well as rotary stations to change from longitudinal to transverse format or vice versa permit an automatic production process.

**2 PRODUCTION LINE –
HOW YOUR PRODUCTION
LINE COULD LOOK
TOMORROW**

For the longitudinal and transverse processing of workpieces in a single pass for medium to large-scale series. Including feeding and destacking systems and automatic throughfeed drilling machines.

Flexible Production Down to Batch Size 1

Customers are increasingly looking for personal furniture. As a result, there is a trend towards batch size 1 production, particularly in Europe. When implementing new production lines, we aspire to combine variant diversity and batch size

1 production with outstanding economy. The K 600 always provides the right technical solution without compromising flexibility and output.

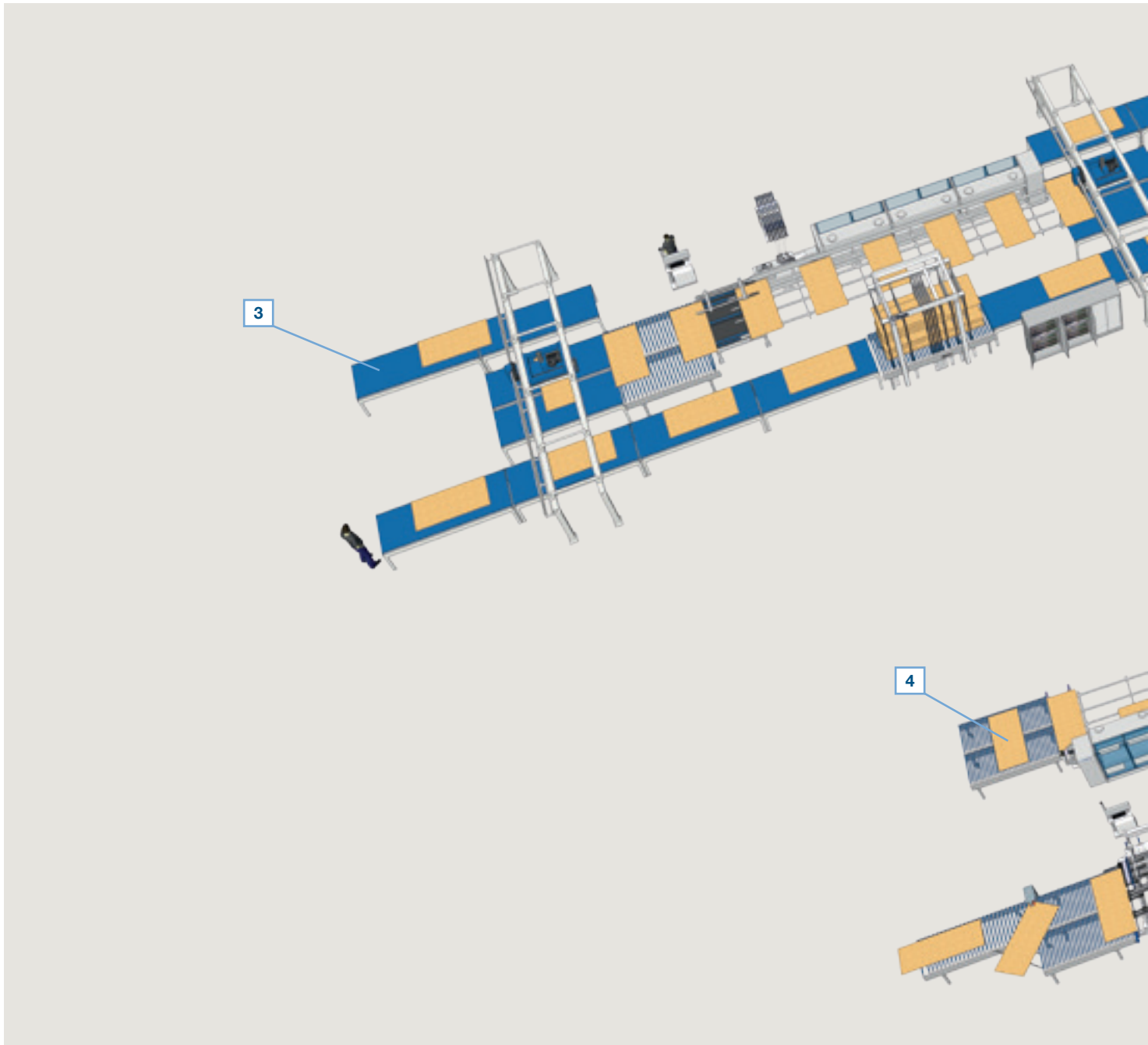

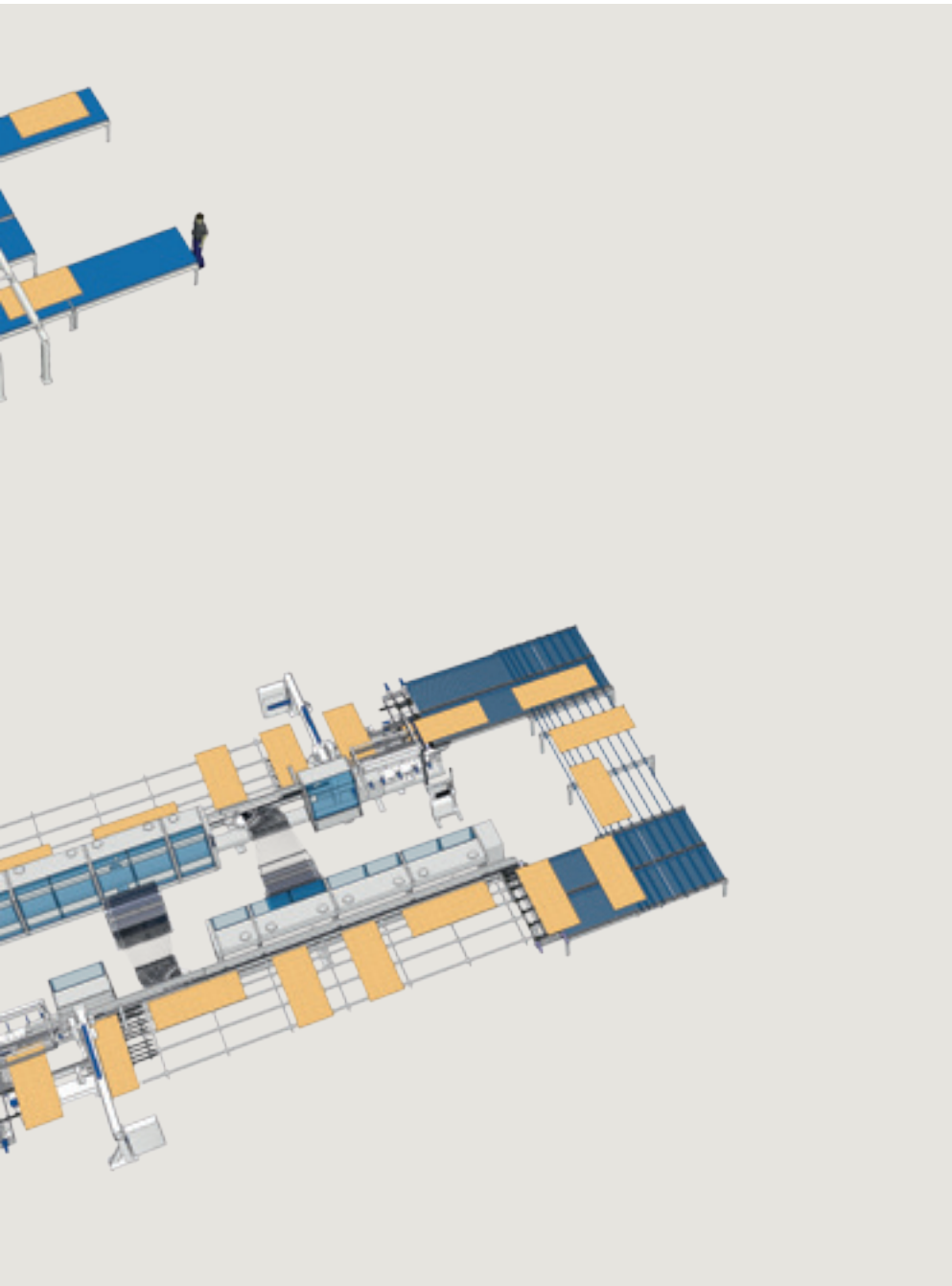
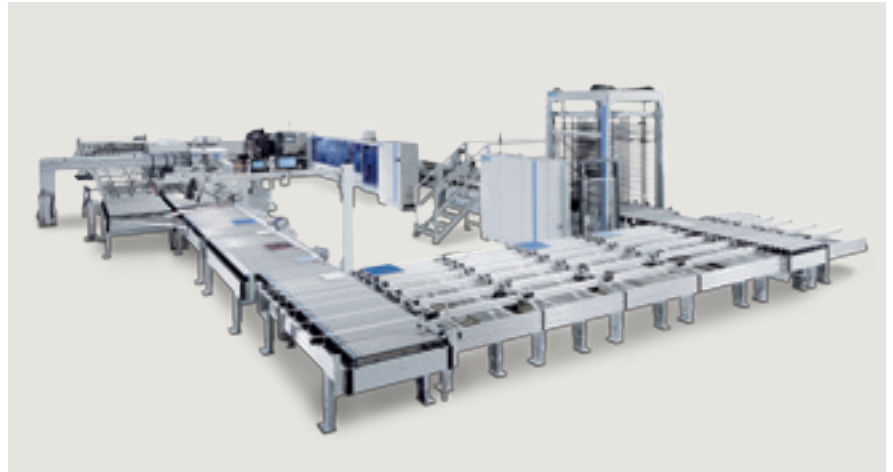

3 BATCH SIZE 1 – ALWAYS EFFECTIVE

Production line for longitudinal and transverse processing of the smallest batch sizes down to a batch size of 1.

4 U-LINE – INNOVATION COUPLED WITH EFFICIENCY

For the flexible production of minimal series sizes. Workpieces are sized on two sides. Edge and finish processing take place independent of width on single-sided machines.



TDL 310 – Rotation on one level

Components with extreme dimensions are supported during the rotation process by lift-off rails.



TDL 310 and 510 rotary stations

- TDL 310, longitudinal to transverse rotary station
- TDL 510, transverse to longitudinal rotary station

Upgrading capability for:

- Batch size 1
- Lightweight panels
- Workpieces up to 80 kg or more



TRL 100

TR series roller tables ensure efficient bridging of distances between two processing machines, or are used to create a buffer section. Workpieces are transported by powered rollers.

Dynamic Edge Circulation Solutions

HOMAG transport systems and sizing and edge processing machines work in perfect harmony when it comes to size, performance and speed. They provide the prerequisite for flexible furniture parts production whether it be series or

batch size 1 production. They improve precision and repeat accuracy with high availability and operational reliability. The hardware and software speak the same language. The result: perfectly automated sizing and edge processing.



Edge circulation unit in 2-gantry version

- Processing machines incorporated into the circulation system, such as sizing and edge banding machines, can carry out automatic production
- Maximum repeat accuracy during collection, delivery and transport of the workpieces
- Variable workpiece positioning, longitudinal or transverse, through -90, +90 and 180 degree rotation
- High drive dynamics with just 0.4 seconds per stroke movement and 1.3 seconds for 90 degree rotations
- Damage to the panel material is virtually eliminated
- The space required for transport and implementing the gap between workpieces is reduced to a minimum
- High drive dynamics with just 0.4 seconds per stroke movement and 1.3 seconds for 90 degree rotations

Greater Economy Due to a Long Service Life and Optimum Availability

The robust design of the machine stand, the advanced technology of the rolling block link chain and the precision of the width adjustment all ensure that your workpieces are processed with maximum dimensional accuracy and

efficiency. The optimized chip and waste piece disposal and the targeted use of several drives enhance machine availability and service life.



Sophisticated technology

All machines of the K 600 series are equipped with a rolling block link chain. This progressive technology ensures that all workpieces are transported with pinpoint precision and processed with extreme dimensional and repeat accuracy. The optimized chip and waste piece disposal enhances machine availability and service life. Experience has proven that the HOMAG block link chain is far less susceptible to wear than block link chain types with semi-circular rod. The proof: outstanding performance over a feed distance of more than 200 meters, even in dusty environments.



Robust and variable

The torsionally rigid dual frame construction of the machine stand forms the foundation for the extreme processing precision of all units.

The variable stand design permits the entire HOMAG range of modular units to be accommodated on the K 600. Simply tell us what it is you require.

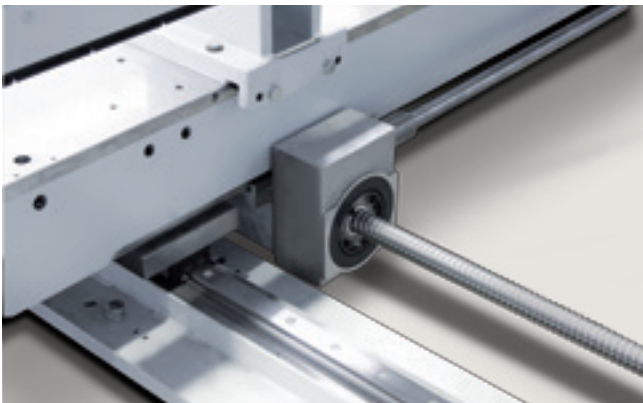
**Width adjustment with the utmost precision**

A drive system with ball spindle and linear guide as well as wear-free flat guides is used for reliable width adjustment.

**Even better with double-sided processing**

In double-sided machines, we use two drive systems linked by an “electronic shaft”. This means that the two sides of the machine have their own drive systems which work interactively. Long machines are fitted with two additional drive systems at the infeed to electrically stabilize the transport chain. This ensures permanent angular precision during production.

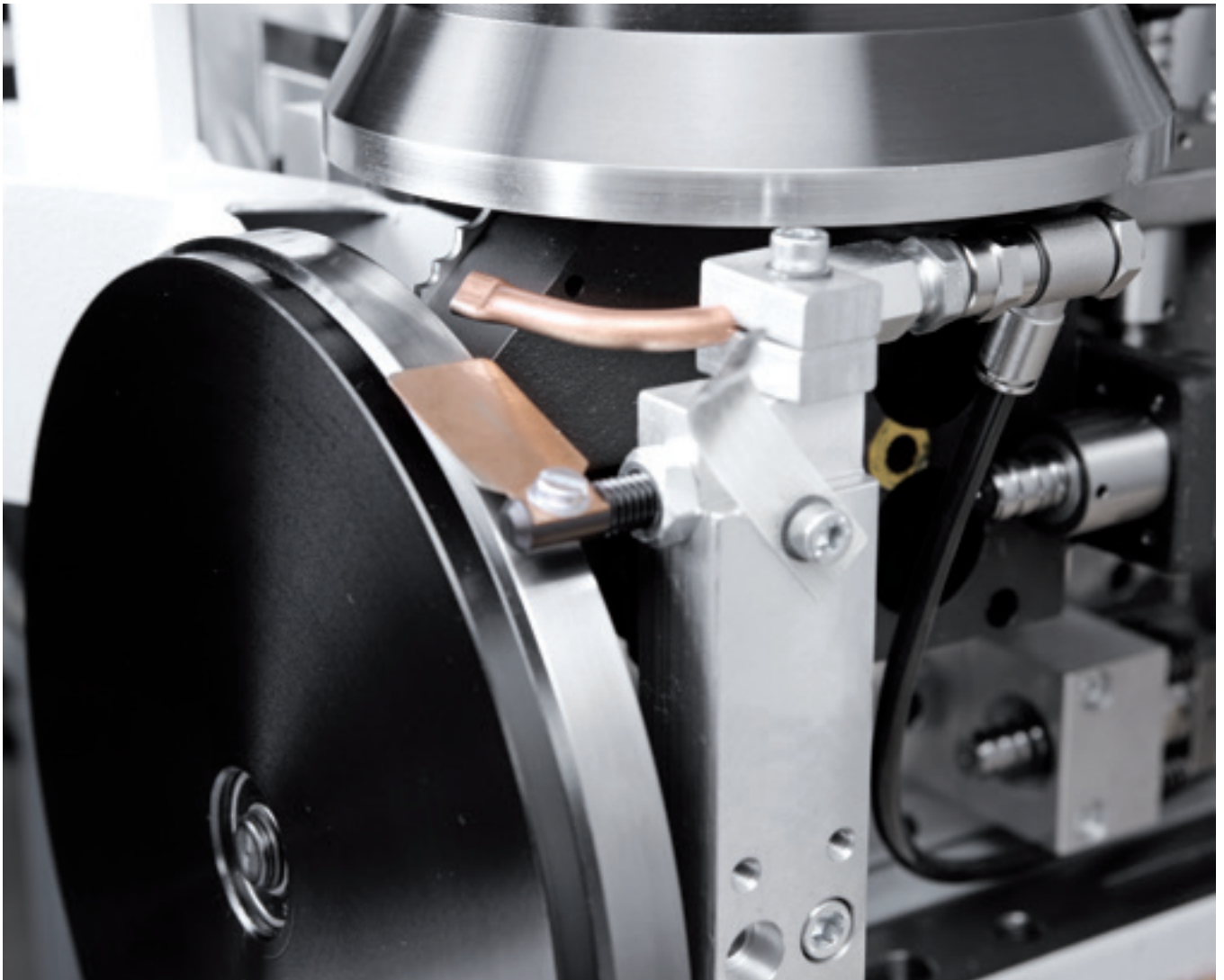

Our Range of Modular Units – Always Up To Date

A wide range of different units is necessary to cope with varied processing operations. By continuously extending our range of units, we ensure that you have the right solution

available to cope with changing trends. Their extreme precision and state-of-the-art technology will boost the flexibility and efficiency of your production.

Jointing and Alternating Trimming – Here Every Step is Ideally Coordinated

Top quality results can only be achieved through smart coordination of every production step to achieve enhanced efficiency. This is precisely what HOMAG does: the units

used for workpiece preparation provide the basis for perfect glue joints.

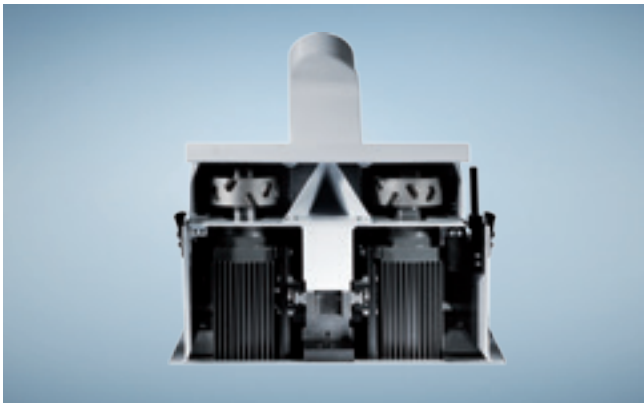

Jointing trimming

This unit permits a high level of processing precision, is extremely hardwearing and is also designed to ensure an above-average service life. The tool diameter is 125 mm.



Compact alternating trimming unit KW12

If larger tool diameters than 125 mm or higher motor outputs are required for jointing trimming, the KW12 compact alternating trimming unit offers the perfect solution.

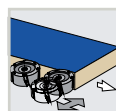
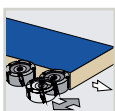

Sizing Units – Your Assignment, Our Solution

HOMAG hogging units are true professionals when it comes to workpiece sizing. Whether coreboard panels, coating ply overhang or transverse veneer – HOMAG plants are happy to

cope with whatever you throw at them. The result is high-quality, splinter-free sizing.

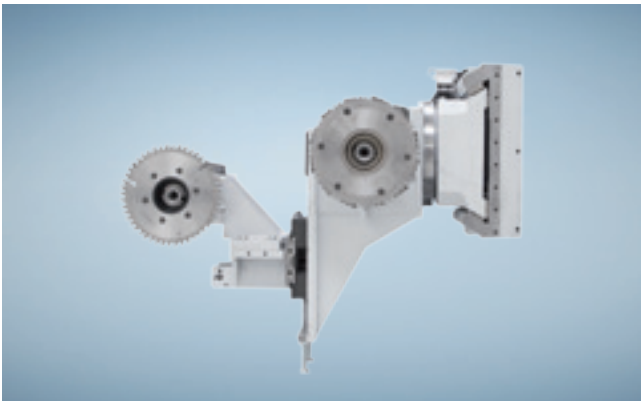

Scoring/hogging

Perfect panel sizing without splintering – even with coated or veneered panels. Pre-scoring unit optionally with lift-off fixture. Hogging unit with cross support and dust hoods.

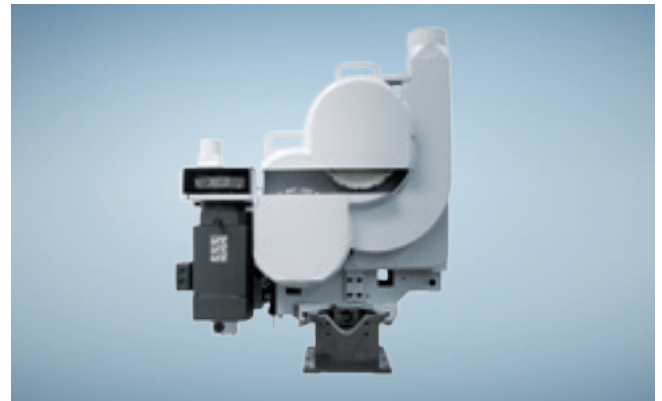

Compact double hogger KD11

With power ranging from 6.6 – 11 kW, larger processing allowances can also be reliably cut in a clean, splinter-free manner. For hogging workpiece sizing in longitudinal and transverse operation with three high-performance motors. Two hogging units with a diameter of up to 250 mm can be mounted.

- Automation to suit every need
- Automatic height adjustment
- Program controlled automatic overhang adjustment

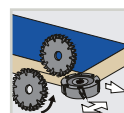
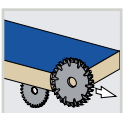

Sizing and Trimming – Neat, No-Fuss Performance

The output speaks for itself: HOMAG standard trimming units allow you to rebate, groove and profile – optionally also with tracing. Choose from the standard trimming unit or the

trimming unit SF62 which is characterized by its outstanding processing versatility.



Standard trimming, horizontal/vertical

Using the standard trimming unit, grooves and rebates can be trimmed precisely inside the machine without the need for an additional processing operation.

Optionally also possible:

- Intermittent control with servo drive for optimum precision
- HSK pushbutton for fast tool change with high repeat accuracy

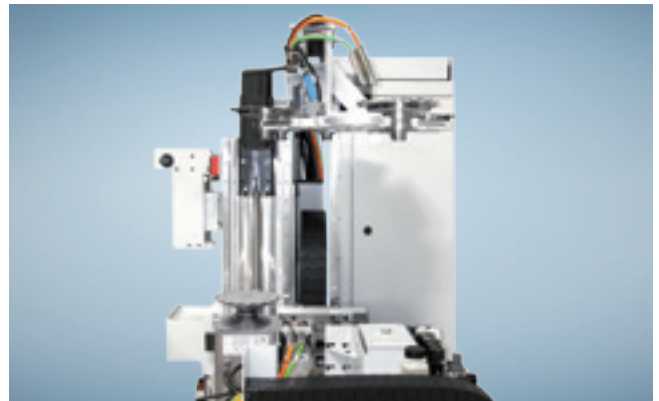
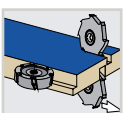

Trimming unit SF62

Groove, rebate and profile with excellent variability. The HSK toolholder and 8-slot plate changer permit outstanding processing versatility. The servo axis affords optimum adjustment accuracy.

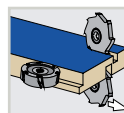

Gluing Units – Sticking With the Best

HOMAG gluing units are the professional solution for a fast, positive-locking glue bond. The standard gluing unit uses the pre-melt system. The heated glue roller ensures an optimum gluing temperature, while magazine height adjustment offers

scope for processing wide-ranging workpiece heights. A simple, toolless quick changeover of the application unit allows other glue colors to be deployed with minimum delay.

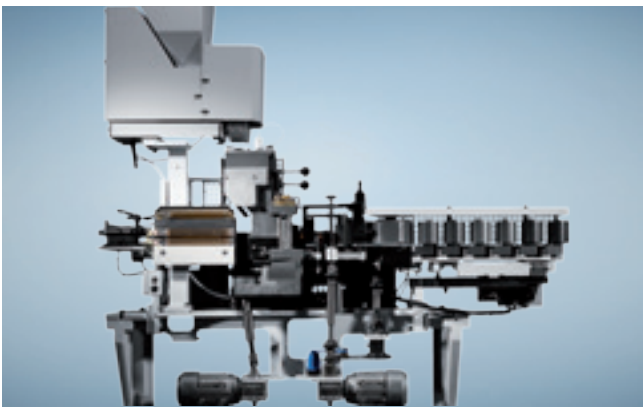

Hot-melt gluing unit

For optimum glue application on the narrow surface. Changes to workpiece thicknesses do not necessitate resetting of the glue application roller.

Quick-release clamping system for application unit

A quick-clamping system is optionally available for the application unit which permits fast hot-melt glue color changeover. This allows hot-melt glue changeover without mixing the different glue colors.

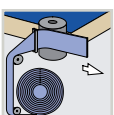

Melting unit with granulate tank

With a melting rate of 18 – 35 kg/h, there is always plenty of hot-melt glue available. Even quantities of up to 45 kg/h pose no problem.

PU melting unit

A range of possibilities are available for melting PU. Please get in touch.



laserTec – the Quantum Leap in Furniture Production

Edge banding with zero joint quality: HOMAG laserTec is a production method which has revolutionized furniture manufacture from the ground up. With this method, a special adhesive coating on the edging strip is melted by a laser

beam and then pressed directly onto the workpiece. The result: edges complying to the highest conceivable standard of quality. Under patent law in Germany only usable with Rehau edge.

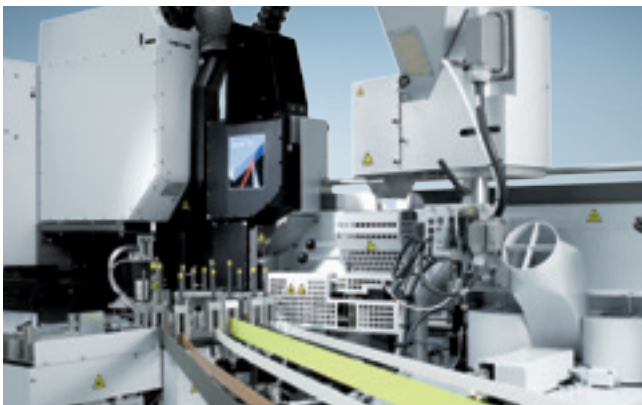

For the entire laser edge spectrum

HOMAG laserTec can be used to process all customary types of edging such as PVC, ABS, PP, PMMA, wood veneer or melamine. The laser-active layer can be individually adjusted in line with product and customer requirements.

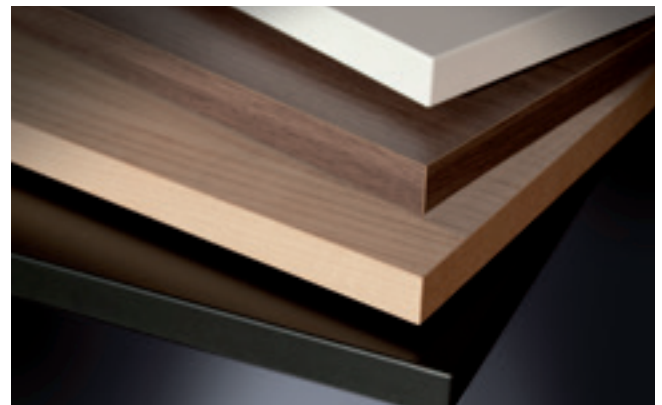

HOMAG laserTec achieves extreme production economy

- Reduced rejects quota
- Simple operating processes
- Low additional costs
- Maximum level of availability
- Reproducible production parameters
- Resource-saving production
- Extreme production reliability

Edge Feed – Varied and Precise

Servo edge feed does more than just sound impressively high tech – it actually cuts out edging waste and so tangibly reduces piece costs. We have actually patented this precisely dimensioned edge feed system with its ultra-minimal

workpiece corner overhang – after all, it was invented by HOMAG. HOMAG offers you a wide edge feed range, from single and dual-slot magazines right through to a changer with 12 or even more slots.

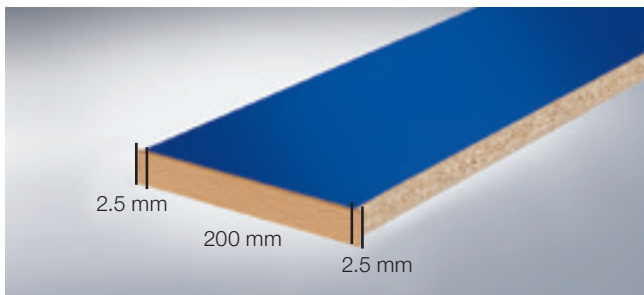
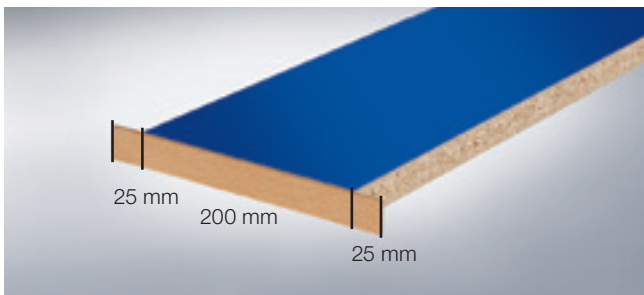

Above: previous gluing technique

Below: optimized gluing technique with servo edge feed

Lower waste, fewer costs

The servo edge feed system feeds the edging material precisely dimensioned to the workpiece corner with only the barest minimum overhang. It permits leading and trailing edge precision of +/- 2 – 3 mm.



Multiple edging magazine

The range covers single and dual-slot magazines right through to changers with 48 slots, allowing edges ranging from 0.3 – 3 mm to be processed with ease.

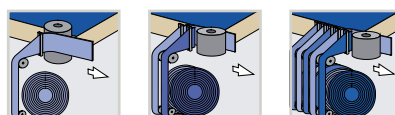

Softforming – Raising the Profile of Your Edges

HOMAG edge banding machines rank among the creative stars of the industry. They provide interesting edge design options. Thanks to softforming technology, the profile shapes

available to edge designers range from roof and drum profiles through to S-shapes or inlay profiles.

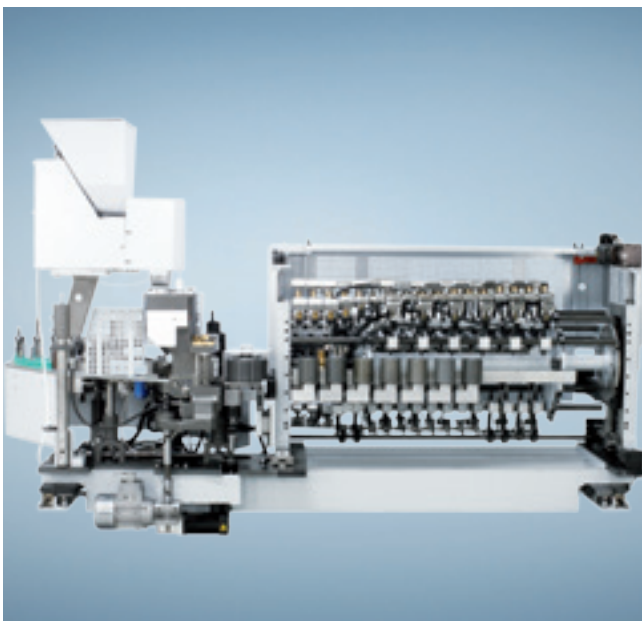
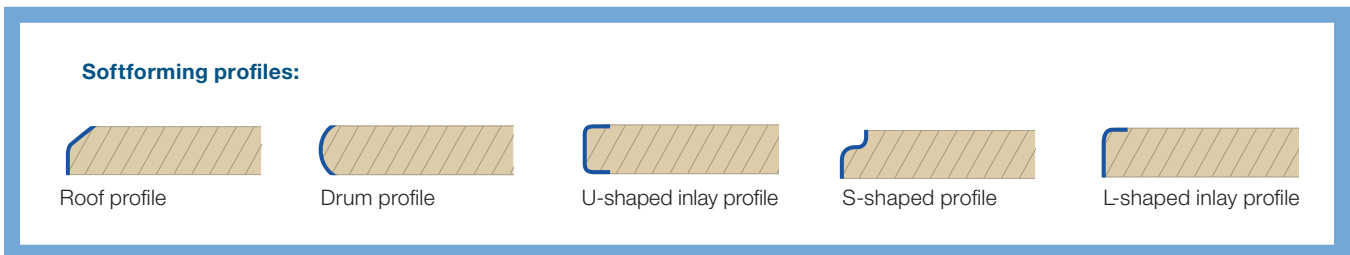

Softforming unit with pressure zone for different profiles

With a melting unit of 18 – 35 kg/h, there is always plenty of hot-melt glue available. If required, the melting output can be increased to as much as 45 kg/h using elements from the tried-and-tested range of HOMAG modular units.

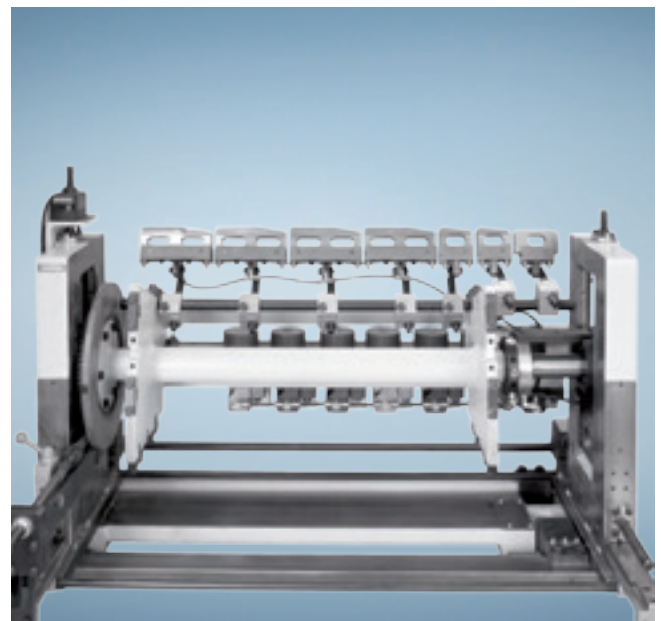

Four-fold multiple-pressure zone G

With a set of pressure rollers for straight edges. This comes with an additional three free spaces. Simply turning the pressure zone changes the profile. The pre-set profile rollers of the roller set can be quickly and easily exchanged.

Optional: profile pressure pad sets

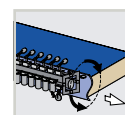
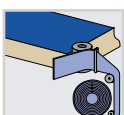

Snipping Units – the Perfect Preparation for Trimming

We are presenting a range of true team players. The snipping units prepare the workpieces perfectly for subsequent trimming operation. The face side can be snipped either straight or with chamfer. If the profile trimming team player is

brought in off the bench, then a piece of edging material is left in preparation for the optimum trimming result.

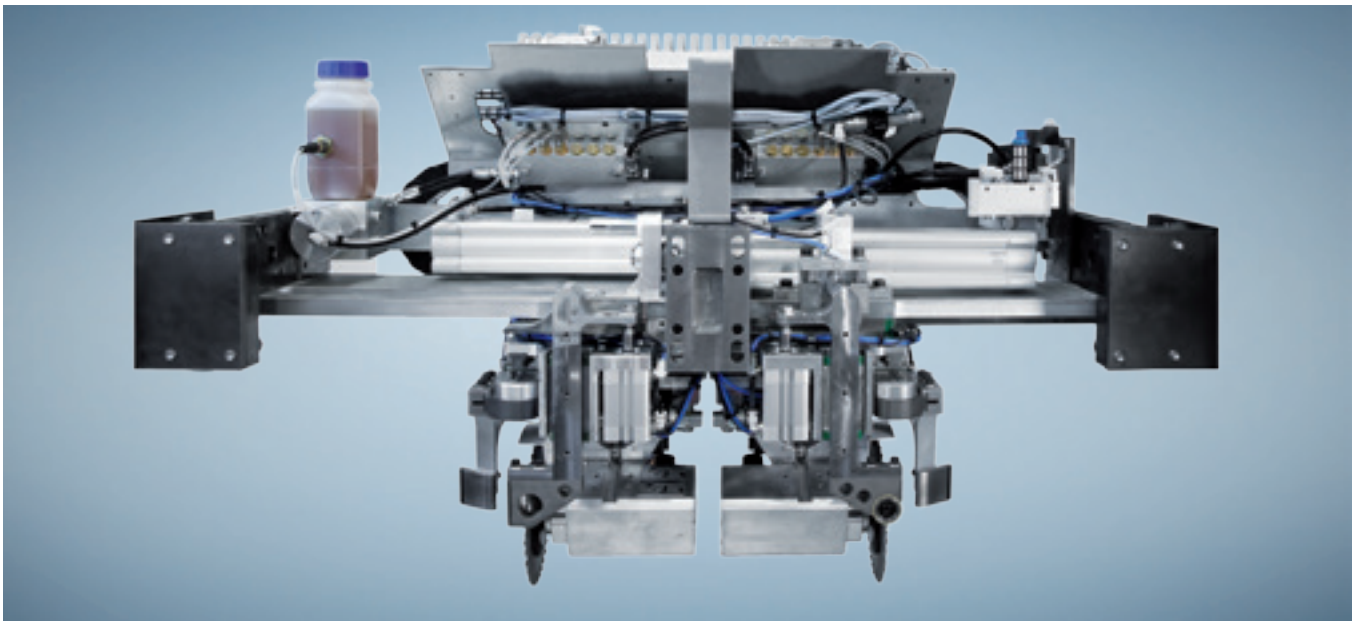

Snipping units PK25 and PK30

For snipping the overhanging edges at the leading and trailing workpiece edge with stationary snipping stop to protect sensitive workpieces from damage. The units are driven pneumatically.

Use of the snipping units PK25 and PK30

For machines with feed rates of up to
25 m/min = PK25
30 m/min = PK30

Automation as standard

Programmable chamfer/straight snipping motor adjustment for fast changeover between straight snipping and snipping with chamfer.

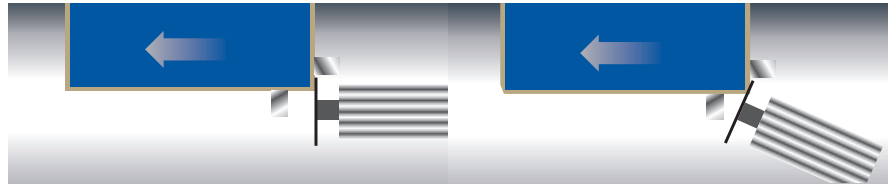

Automation as standard

For fast changeover between flush snipping (e.g. of solid moldings or inlay shelves) and snipping with overhang, e.g. for finish trimming with profile trimming unit.

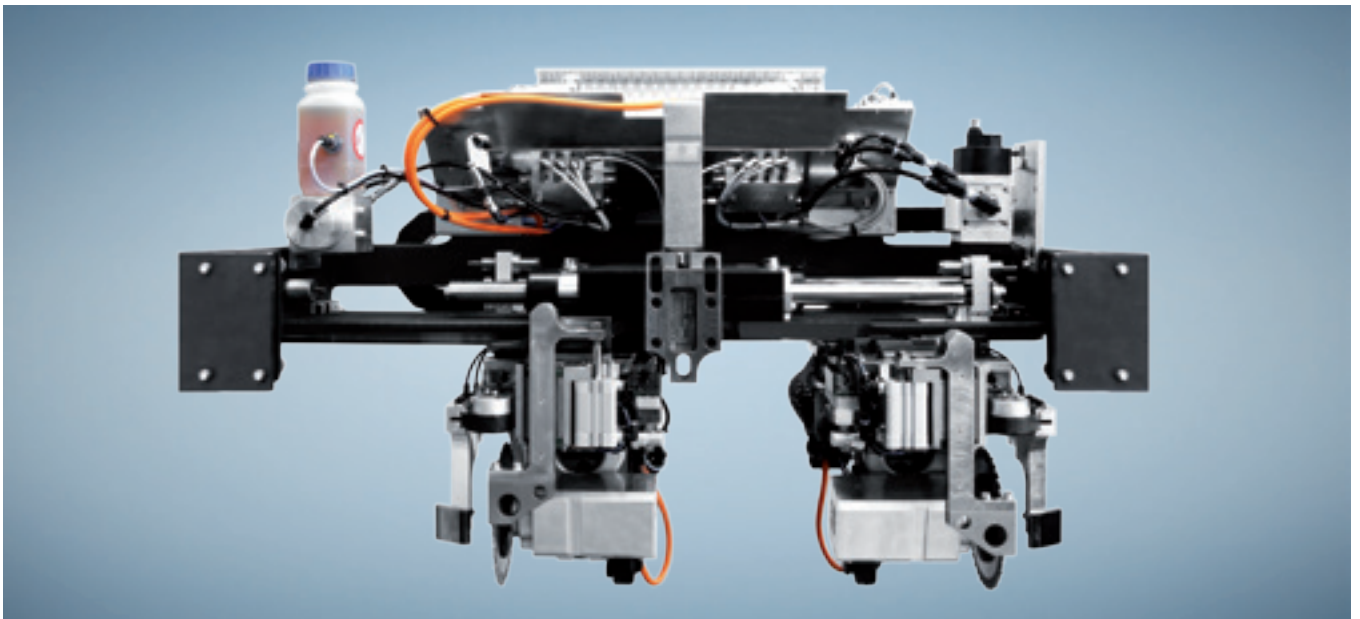

Snipping units SK25, SK30 and SK35

For snipping the overhanging edges at the leading and trailing workpiece edge with stationary snipping stop to protect sensitive workpieces from damage. The units are driven by servo motor.

Use of the snipping units SK25, SK30 and SK35

For machines with feed rates of up to
 25 m/min = SK25
 30 m/min = SK30
 35 m/min = SK35

Trimming – the Solid Basis for Edge Processing

HOMAG trimming units give the workpiece edge its required shape. Practical solutions are guaranteed, even with our basic units.

The rough trimming unit BF20 is ideal for rough trimming the upper and lower overhanging edge and trimming unit PF20 for trimming chamfers or radii at the edges.



Rough trimming unit BF20

For rough trimming the upper and lower overhanging edge.

Automation to suit every need

For automatic changeover from flush trimming to trimming with overhanging edge.



Flush



Overhang



Trimming unit PF20

For trimming edge chamfers or radii. Options: stepless or pneumatic adjusting devices for the trimming motor. Trimming motor exchange using exchange units.

Trimming unit PF20/21 flexTrim

For automatic changeover between different profiles, for instance R2 and R3.

Multi-trimming unit MF21

For automatic changeover between different profiles, for instance chamfer 20°, R2 and R3.

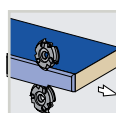
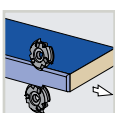
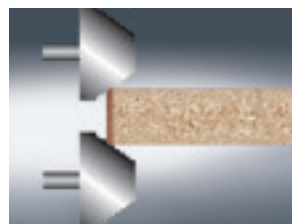

Profile Trimming – for Rounded Edges

HOMAG profile trimming units are true professionals when it comes to trimming. As a user, your job is to program any profile that takes your fancy; then stand back and watch the extreme speed and precision of the expert execution. The

efficient mode of operation results in higher productivity. Our dual-motor profile trimming units permit both corner rounding and trimming of upper and lower overhanging edges.

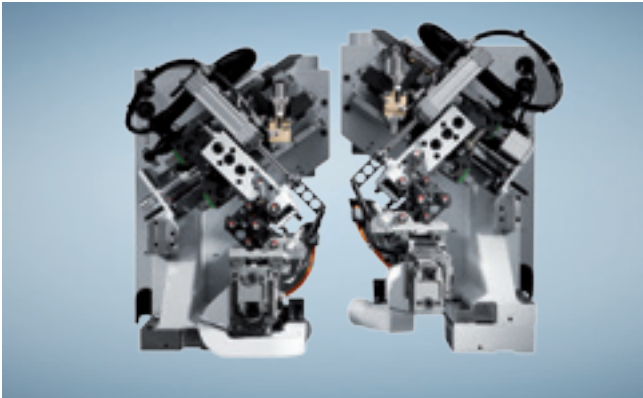

Profile trimming unit FK11

For trimming around the leading and trailing edge and for trimming the top and bottom edges.

Automation to suit every need

Stepless chamfer/radius adjustment for fast changeover from 0.4 mm to 2 mm edges, for example.

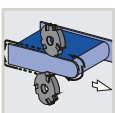

Four-Motor Profile Trimming Tools – Take Anything in Their Stride

The four-motor HOMAG profile trimming units ensure reliable corner rounding even when processing veneer. Are you looking for a unit for flush trimming the upper and lower workpiece surface? Then you have come to the right place.

The flexTrim exchangers for the fast exchange of two profiles in the gap between workpieces can be mounted on profile trimming units FF32 and FF42.

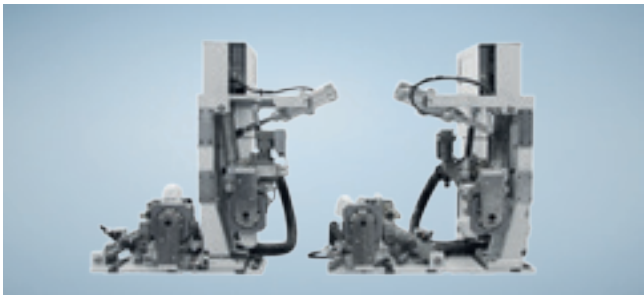
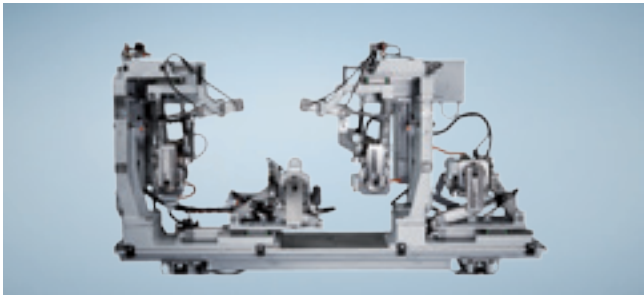

Profile trimming unit FF42 (top)

For four-motor profile trimming at speeds of 35 m/min.

Profile trimming unit FF32 (bottom)

For rounding top and bottom edges on the leading and trailing workpiece edges. By dividing the cut over four motors, each corner can be processed in synchronous rotation, thus reducing the risk of splintering even with veneer.

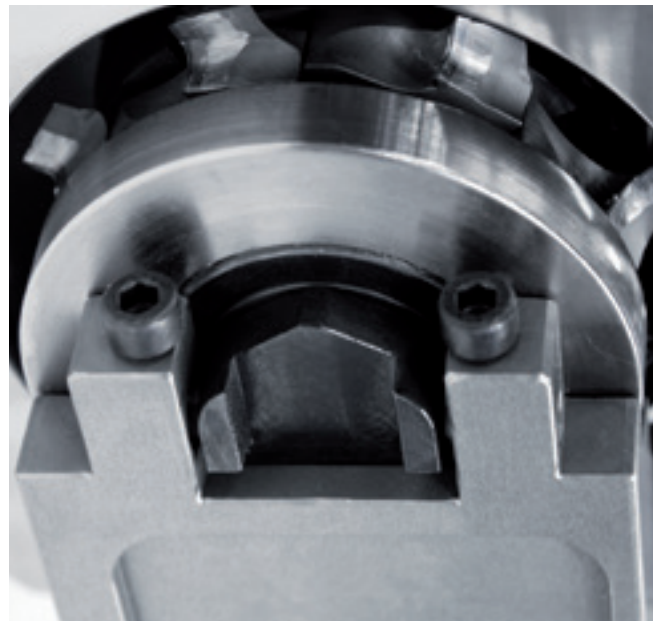

flexTrim

The flexTrim exchangers can be mounted on trimming and profile trimming units. They permit the fast exchange of two profiles within the gap between workpieces.

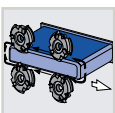

Servo Profile Trimming – Making You Even More Efficient

Expecting higher performance, greater contour variety and even higher quality? Then we recommend our servo profile trimming units FK30 profiTrim and FK31 powerTrim. As the drive uses modern linear motors, the movement sequence is

controlled by the program when trimming around the edge band on the narrow surface of your workpieces.



Profile trimming unit FK30 and FK31

For trimming around the leading and trailing edge.
With servo motor-driven tracing axis for sensitive surfaces or softforming profiles.

Use of the profile trimming units FK30 and FK31

For feed rates
20 or 25 m/min = FK30
30 or 35 m/min = FK31

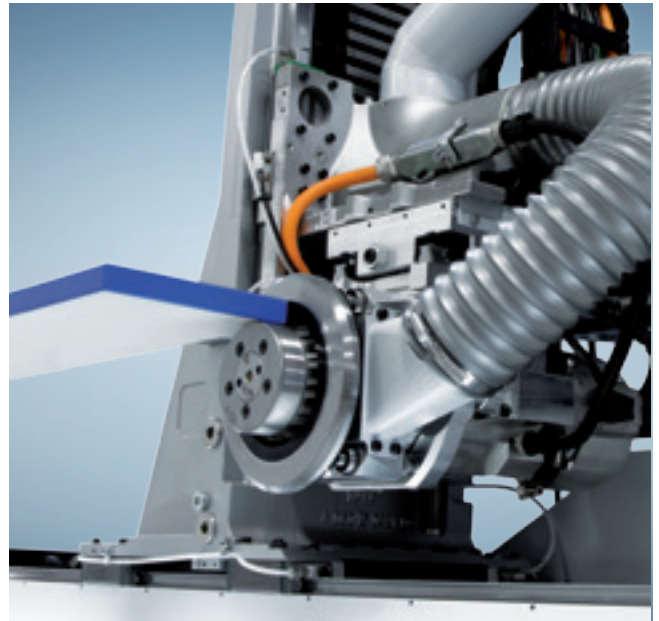

Automation to suit every need

- Adjustment to three different radii and chamfer
- Automatic adjustment of the tracing roller diameter
- Automatically adapted tracing force
- Automatically adapted speed

FK 31: steplessly adjustable tracing force

E.g. for honeycomb boards and soft materials

Finish – All's Well That Ends Well

The following principle can be applied to production as well as to a marathon: those who persevere to the very end will achieve their goal. For a perfect finish which has you running victoriously to the winner's podium, place your trust in

HOMAG. There are a range of possibilities available to make this happen. Depending on your requirements, choose the profile scraper unit PN20, the multi scraper unit MN21 or finish processing unit FA21.



Profile scraper unit PN20

For smoothing trimmed edges to achieve an optimum appearance.

Multi scraping unit MN21

For automatic changeover between a maximum of five different profiles.



Finish processing unit FA21

Comprising a glue joint scraper unit for disposal of glue residues at the top and bottom of PVC edges and a buffing unit.

Optimum surface quality

through precision adjustment of the glue joint scraper blade to ± 0.01 mm

- manually (as standard)
- automatically (optional)

Automatic adjustment of the glue joint scraper unit

To suit foil thickness for workpieces with and without protective foil.

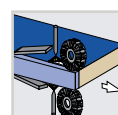
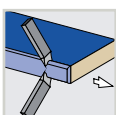

Finish Belt Sanding – Always on Top Form

Whether straight edges, chamfers or radii, whether veneer or solid wood. You can rely on our HOMAG belt sanding units –

belt sanding unit KS10, belt sanding unit PS20 or chamfer/radius sanding units PS41 and PS42.

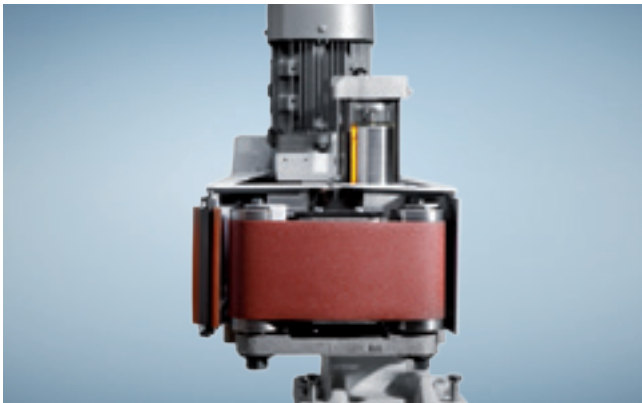

Belt sanding unit KS10

For sanding straight veneered and solid edges including oscillation as a standard feature.

Belt sanding unit PS20

For profile sanding using dual pad technology with two separately adjustable sanding pads.

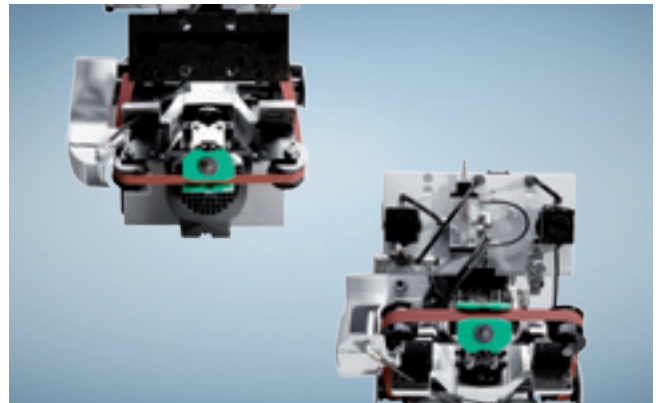

Chamfer/radius sanding unit PS41 and PS42

For sanding chamfers and radii at the top and bottom of veneered and solid wood edges.

Automation to suit every need

For traversing out of the work area and stepless adjustment to different edge thicknesses.

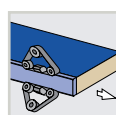
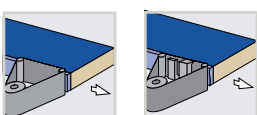



Control with powerTouch

Using the widescreen format multitouch monitor, you control machine functions by direct touch contact. The ergonomically optimized design and an array of new help and assistant functions substantially simplify operation.



Standardized

Standardized operating elements, software modules and standardized design characterize the powerTouch control system for HOMAG machines. This allows different HOMAG machines to be controlled in the same way.



Ergonomic

Intuitive, direct control via the touch-sensitive touchscreen monitor.



Evolutionary

Design and function united in one control system. The futuristic powerTouch machine control system is combined with state-of-the-art operating concepts used in smartphones and tablet PCs.

powerTouch – the Innovative Control System: Easy, Standardized, Ergonomic and Evolutionary

HOMAG machines are designed to make easy operation and reliable control a matter of course. Our innovative touchscreen operating philosophy combines design and function in a single control system. The full HD multitouch

monitor, ergonomic touch operation, simple navigation and the standardized user interface all enhance processing efficiency.

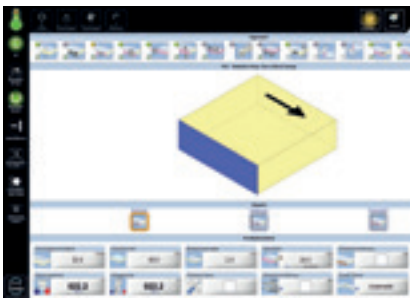

Programming with woodCommander

User-friendly programming system using graphically supported input screens.



Support via TeleServiceNet Soft

High-speed servicing and assistance through targeted fault analysis and support over the Internet.



Evaluation with MMR Basic

The software evaluates the productivity of your machine and supplies usage-dependent maintenance notifications.

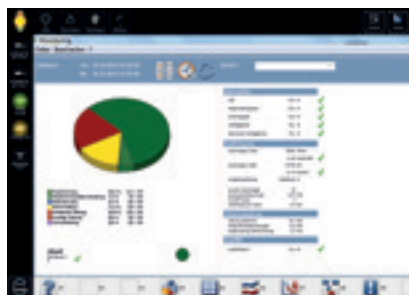

MMR Professional (option)

The MMR Basic upgrade additionally evaluates shifts, analyzes error messages and permits a link to be created to the data evaluation center in the office.



woodScout diagnostic system (option)

Alongside error messages in plain text, woodScout also provides a graphic representation of the error location. In addition to the system's expert knowledge database, users can store their own troubleshooting solutions.

Productivity – Only as Good as the Control System

To increase the productivity of machine lines and production cells, HOMAG relies upon the PC53 production line control system. This allows more workpieces to be processed per shift, and offers scope for economical and varied production.

This not only cuts out operating errors but also allows a reduced staffing requirement. You may safely place your trust in our many years of experience with over 500 successfully installed systems the world over.



Machine control

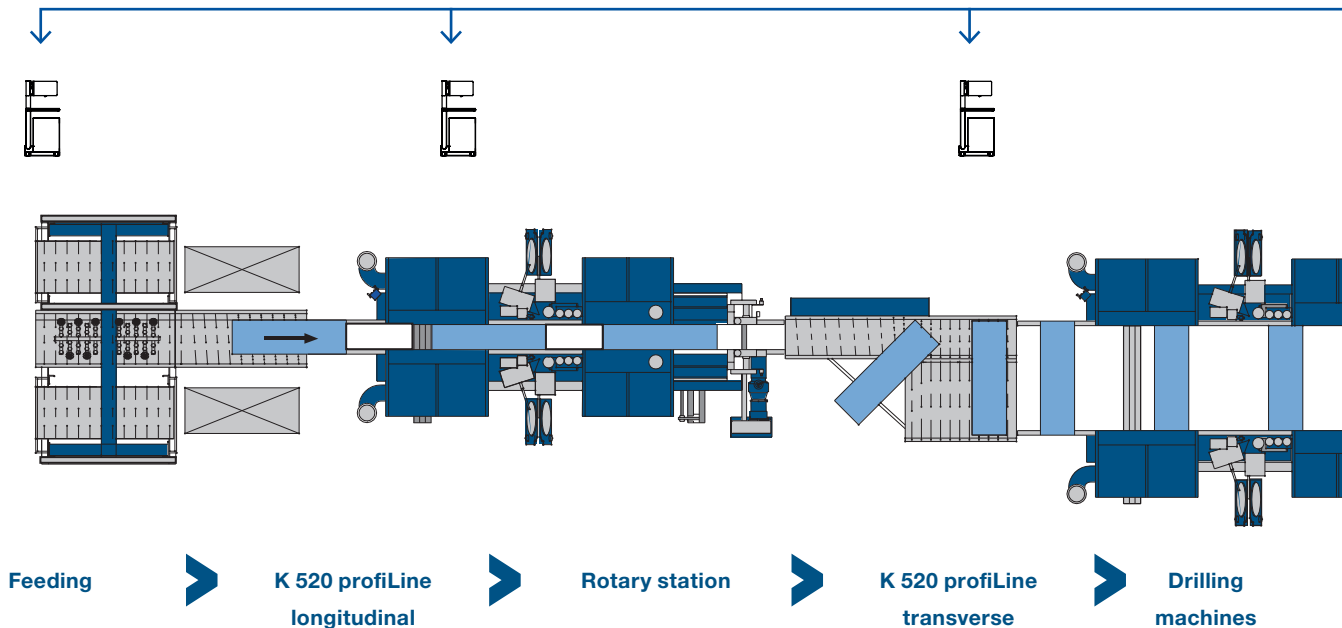

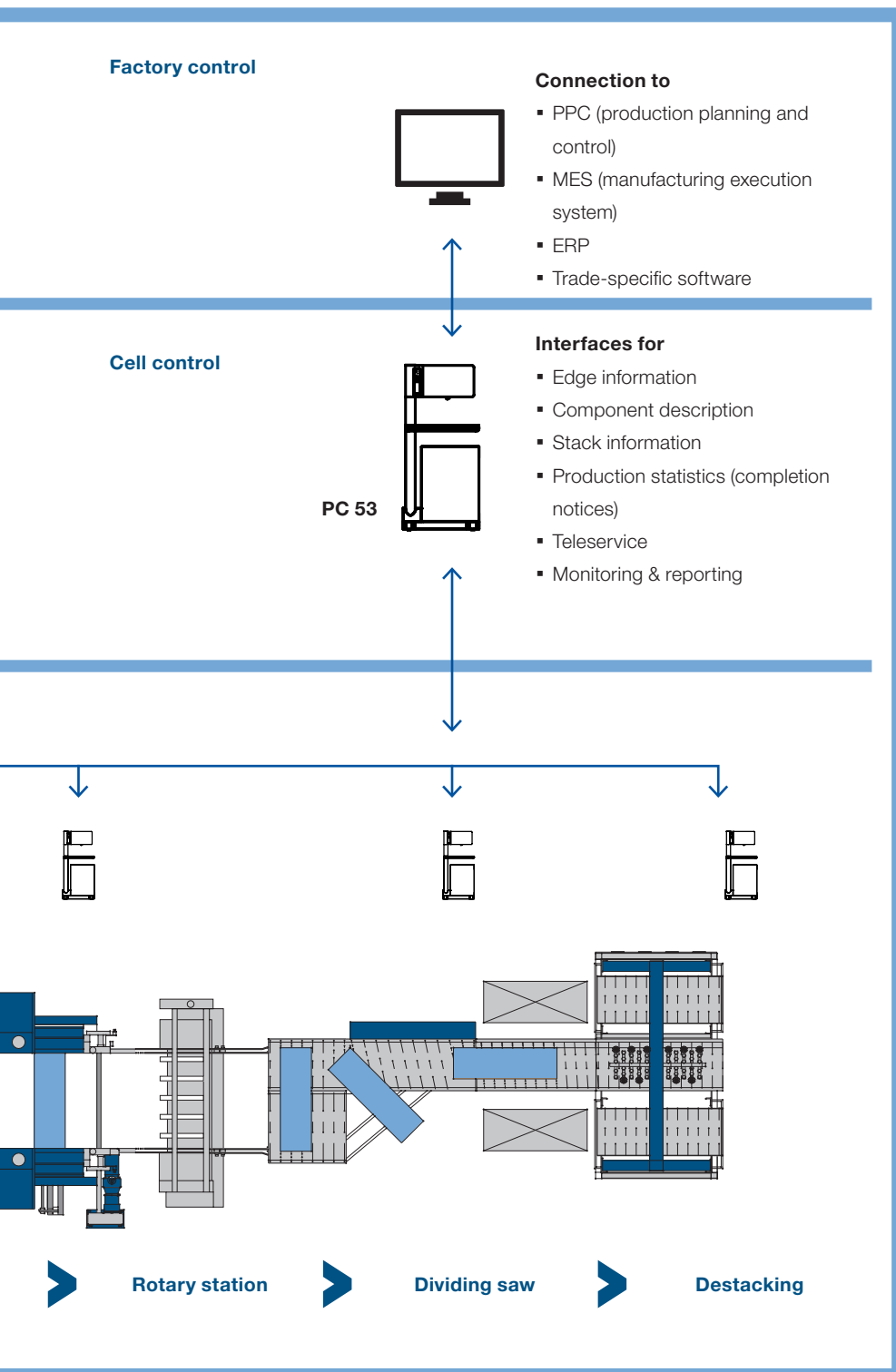

Functional characteristics for improved performance*

- Central production cell operation and monitoring
- Automatic data distribution in the production cell by part tracking and machine networking
- Production sequence control using list management
- Improved performance due to automatic cyclical output and calculation of the gap between workpieces
- Edge preview to reduce standstill times due to missing edging material

Functional characteristics for data organization*

- Central generation and management of component information in an MS-SQL database
- Component identification through automatic and manual bar code reading systems
- Component identification using labeling and ink jet solutions
- Stack management with integrated printout of stack accompanying documents

Functional characteristics to enhance availability*

- woodScout diagnostic system for central display of all line error messages at the cell master computer
- Fast, reliable troubleshooting and remedy using the worldwide teleservice

*Some functional characteristics and interfaces are optional

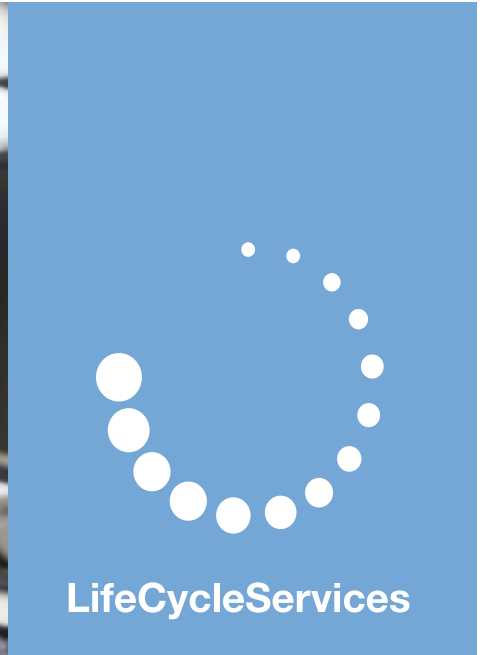

HOMAG Life Cycle Services

The sale of our machines comes with all-in optimum service backup and individual advice. We are here to assist you with innovative services and products tailored to meet all your needs. With short response times and quick customer

solutions, we ensure cost-effective, high availability production for you – throughout the entire life cycle of your machine.



Remote Service

- Hotline Support through remote service with regard to the control system, mechanics and process technology. This results in 85.2 % less on-site service calls
- Mobile applications such as ServiceBoard reduce costs by providing rapid assistance in the event of a fault with mobile live video diagnostics, online service reports, and the online spare parts shop eParts



Spare Part Service

- Identify, request and directly order spare parts 24/7 at www.eParts.de
- Local parts availability around the world thanks to sales and service companies plus sales and service partners
- Reduction in downtimes thanks to defined spare part and wear part kits



Modernization

- Keep your machinery up to date and increase your productivity as well as your product quality, so you can meet tomorrow's product requirements today
- We can help you with upgrades and modernization as well as individual consultancy and developments



HOMAG Finance
– Precisely the Right Financing

- We offer tailor-made financing arrangements for your plants and machines. Our advisory service goes hand in hand with our technical expertise over a wide range of issues. Your personal contact partner will take care of the entire process
- The benefit for you: the ability to invest without delay in new technologies and remain financially flexible

1,200
 service staff worldwide.

650
 spare parts orders processed per day.

85.2 %
 less on-site calls due to successful remote diagnostics.

>150,000
 machines electronically documented in eParts in 28 languages.



Training

- Thanks to training sessions tailored to meet your individual needs, your machine operators will be able to optimally operate and maintain HOMAG machines
- In conjunction with this, you will receive customer-specific training documents with tried-and-tested exercises

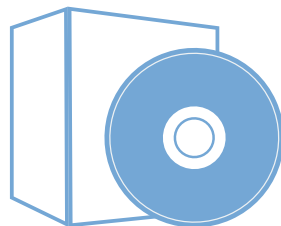

Software

- Telephone assistance and advice through Software Support
- Digitalization of your spare parts by means of 3D scanning saves time and money in comparison to reprogramming
- Subsequent networking of your machine outfit using smart software solutions from design through to production



Field Service

- Increase in machine availability and product quality through certified service staff
- Regular testing through maintenance/inspections ensures top quality for your products
- Downtimes are minimized in the event of unforeseeable faults thanks to the rapid availability of our technicians

Technical Data K 600

MACHINE DIMENSIONS	
Overall length (mm)	according to machine type
Working height (mm)	950
Noise protection covers (mm)	1,840/2,500
Overall width closed/open (mm) plus relevant working width	2,300/3,830
WORKING DIMENSIONS	
Workpiece width (mm)	
min. single-sided	85
min. double-sided	240
max. double-sided	1,000 – 4,000
Graduations	500
Workpiece thickness (mm)	12 – 60 (optional 8 – 100)
Workpiece overhang (mm) fixed	40
Adjustable (optional)	30 – 110
CONNECTED LOADS	
Operating voltage (V/Hz)	400 / 50
Control voltage (V)	220 / 24
Total electrical connected load (kW)	depending on equipment
Total suction output approx. (m ³ /h)	depending on equipment
Chip conveyor belt	optional
Air speed (extraction) (m/sec)	28
Pressure loss (mm/wg)	250
Suction nozzle	depending on equipment
Compressed air connection (bar)	6 – 8
Compressed air consumption (nl/min)	depending on equipment
MISCELLANEOUS	
Feed steplessly adjustable (m/min)	10 – 40 (optional 80)
Width adjustment speed (m/min)	
Standard	2.6
Machines with servo axis	20
Cam spacing/standard (mm)*	1,000
Cam height/standard (mm)*	11
Optional stepless cam height (mm)	up to 25

* For double-sided transverse processing

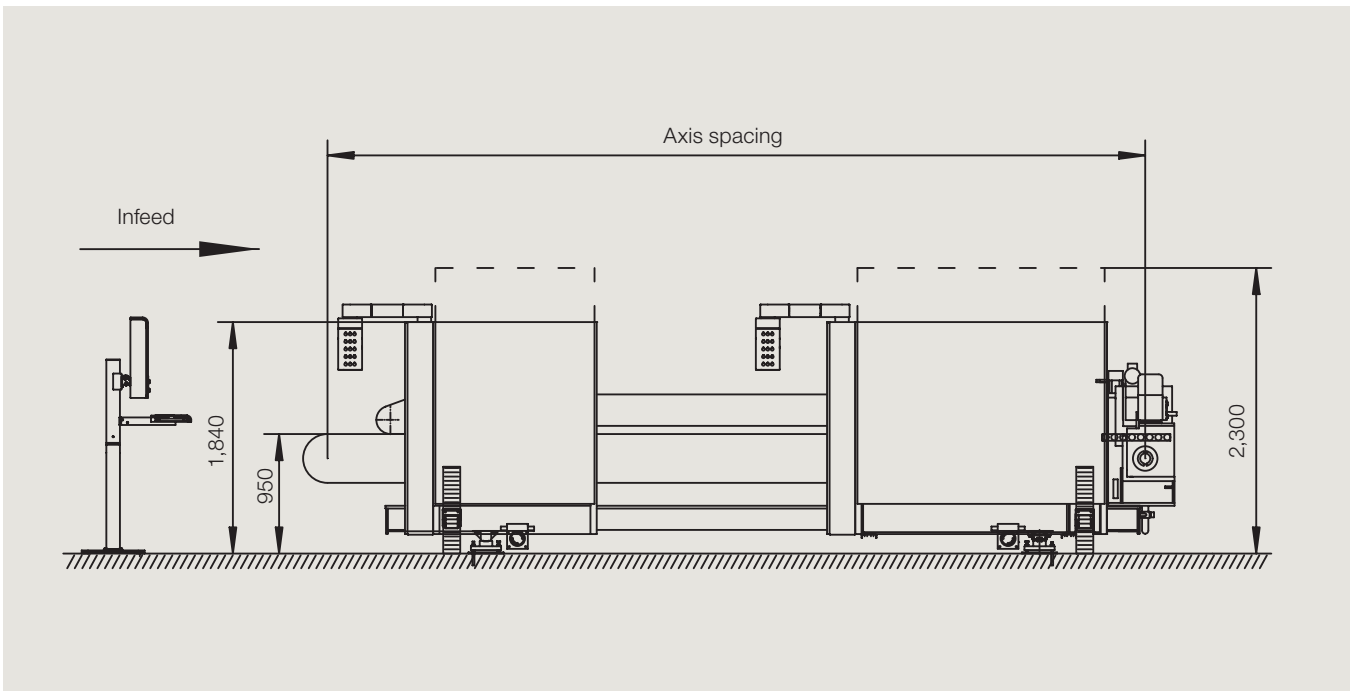

K 600

HOMAG GmbH

Homagstraße 3-5
72296 Schopfloch
Germany
Tel. +49 7443 130
info@homag.com
www.homag.com



**Choose the Original
Choose Success!**

For the Success of Original
Technology
A VDMA campaign